

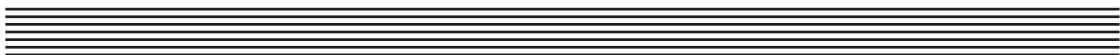

Model LT5000

User's Guide

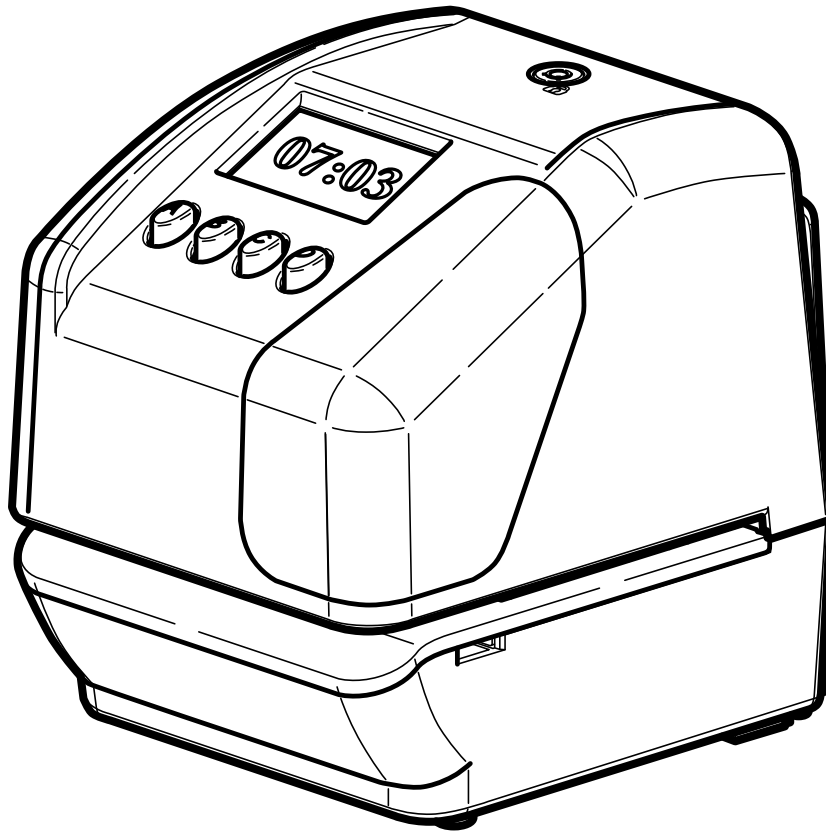

www.lathem.com

Table of contents

Packing contents _____	3
Overview _____	3
Installation of optional battery _____	4
Wall mounting _____	4
Wall mounting template _____	5
Replacing ink ribbon cassette _____	6
Remote setup and additional functions _____	7
Start Setting _____	8
Display _____	8
Icons _____	9
Menu tree _____	10
Format list _____	12
Fixed comment list _____	12
Character list _____	13
Control code list _____	15
Printing Position _____	16
Error/Warning code list _____	17
Reset _____	18
Troubleshooting _____	19
Specifications _____	21
Environmental conditions _____	22
Warranty _____	23

Packing contents

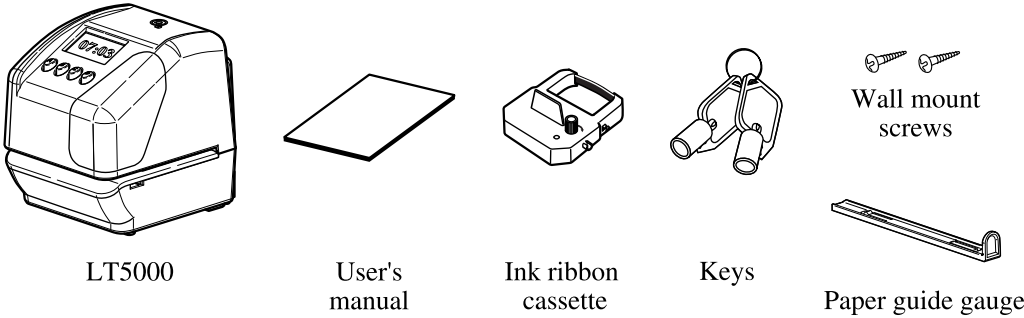

Overview

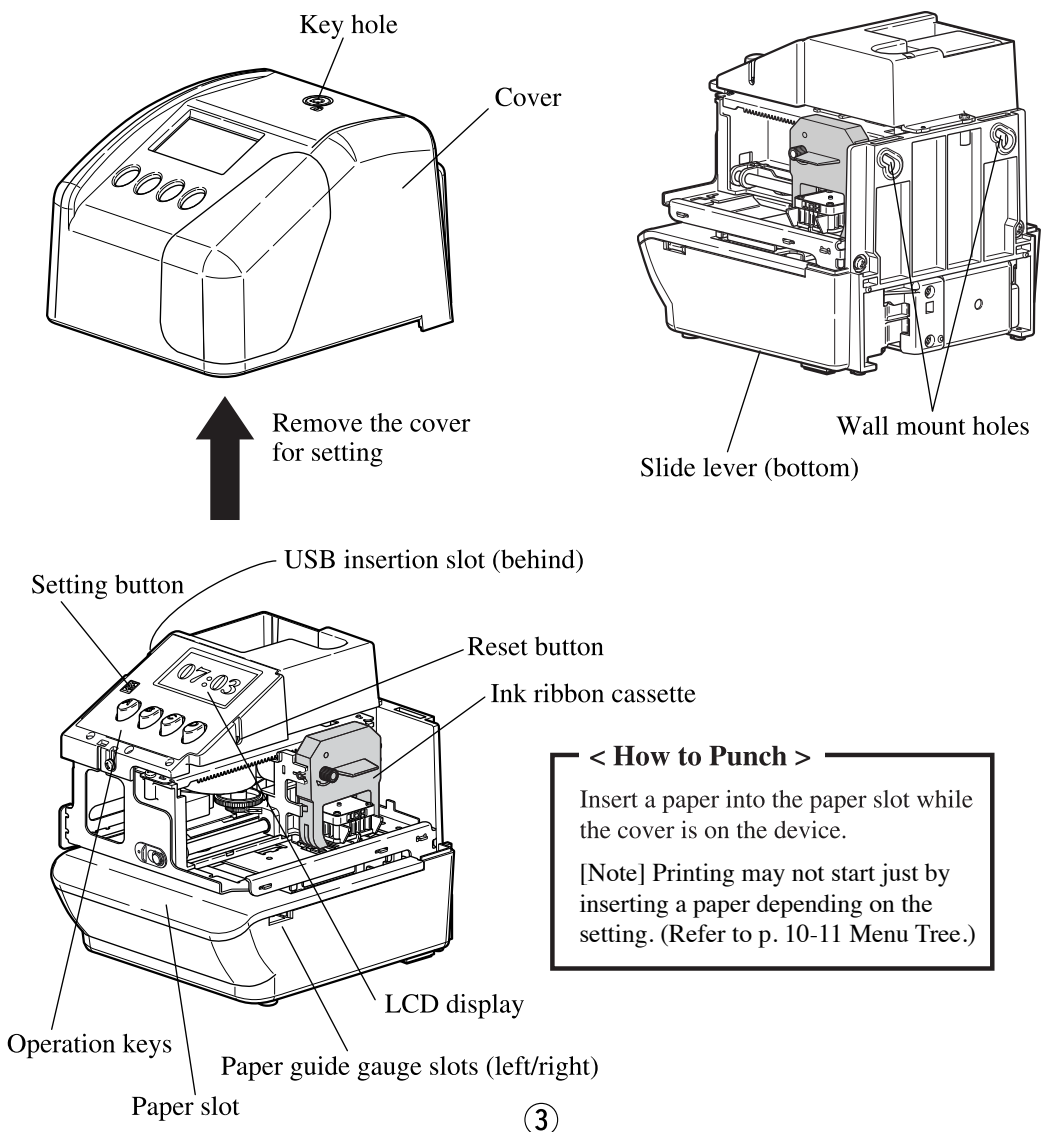

Installation of optional battery

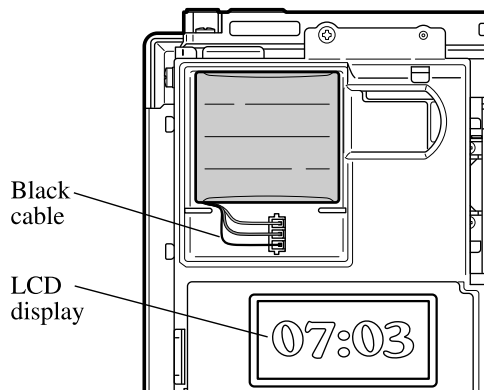

- 1** Unlock the key and remove the cover.
- 2** Insert the battery connector into the compartment connector to install the battery. Be sure to connect the black cable to the display side.
- 3** Replace the cover and lock.

[CAUTION]

Replace the optional Ni-MH rechargeable battery with part number VIS6001 (HHR-06TH7W1) only.

Use of another battery may be at risk of fire or explosion.

Dispose of used batteries in accordance with applicable local regulations.

Wall mounting

[CAUTION]

The supplied screws are intended for use on a thick wooden wall or wooden column. Do not use them on any other materials. The device may come off if used on other materials.

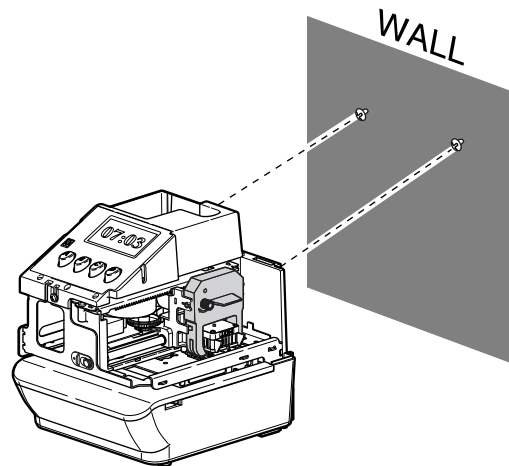
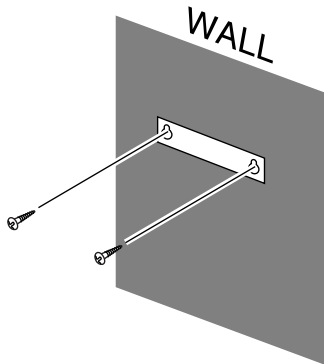

- 1** Install the supplied wall mount screws into a wall by using the template located on the next page. Be sure to keep about 6mm (1/4") of the screw head away from the wall.
- 2** Unlock the key and remove the cover. And then hang it on the wall.
- 3** Replace cover and lock.

Wall mount template

Please copy and use this template when needed.

Leave about 6mm (1/4") gap between wall and screw head.

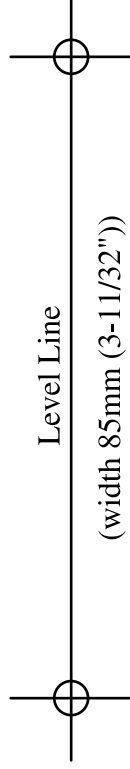

Replacing ink ribbon cassette

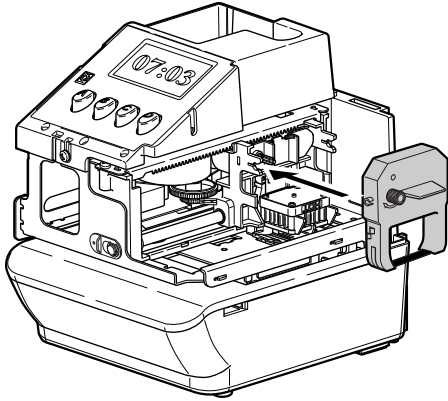

1 Unlock the key and remove the cover.

2 Hold the ink ribbon cassette by its tab and pull straight out to remove it.

3 Turn the knob of the new cassette in the direction of the arrow (clockwise) to tighten the ribbon.

4 Place the cassette inside the device as shown in the figure. Push the cassette until it snaps into the position. Turning the knob on the cassette may make installation easier.

[Note]

Install the cassette so that the ribbon is between the print head and the ribbon mask. Printing will not come out properly if the ribbon is placed under the ribbon mask.

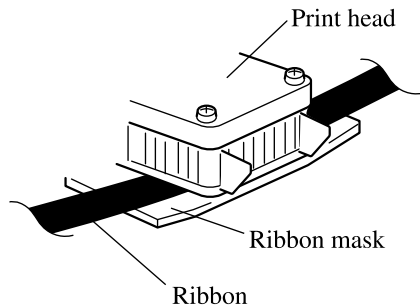

5 Turn the knob of the cassette in the direction of the arrow to tighten the ribbon.

6 Replace the cover and lock.

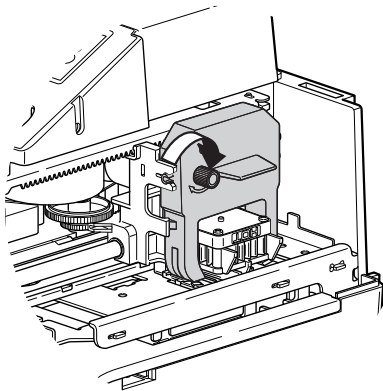

Remote setup and additional functions

This device supports additional remote setup functionality. Additional print settings, counters, flexible content, and custom comments can be easily configured and applied to one or more devices via USB memory disk. Please see further in-box documentation for more details.

[CAUTION]

- The USB insertion slot is for USB memory device only, and will not support other devices. The provided USB interface is compatible with USB 2.0 full-speed (12Mbps) only.
- USB memory device protected physically can't be used on the device.
- Do not remove the USB memory device and do not remove power to the LT5000 during use of the USB memory device. Interrupted communication to the USB memory device could result in loss or corruption of data and damage to the device.
- In no event shall we be liable for lost or damaged data, or recovery of lost or damaged data, on the LT5000 or USB memory device.

www.SetupMyStamp.com

1 Customize Print Set Formats (1 or 2 lines)

Personnalisez les formats d'impression (1 ou 2 lignes) /
Personalizar los formatos del juego de copias (1 o 2 líneas)



2 Assign Print Set to Buttons

Assignez les formats d'impression aux boutons /
Asignar el juego de copias a los botones

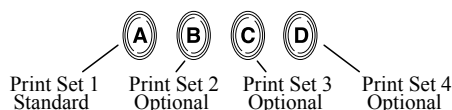
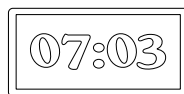

3 Configure Settings and Transfer via USB Drive

Configurez les paramètres et transférez-les par l'intermédiaire d'un lecteur d'USB /
Configurar los comandos y transferirlos desde la unidad USB

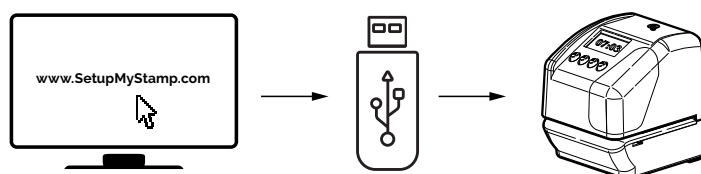

Start setting

To start setting, click down the setting button first. According to indicated icons, click down a corresponding key. (Refer to p.21 Menu tree.)

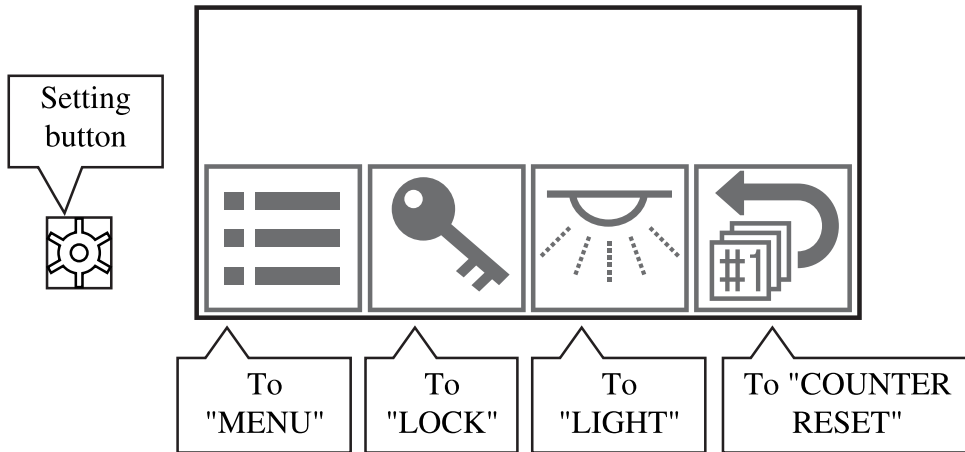

Display

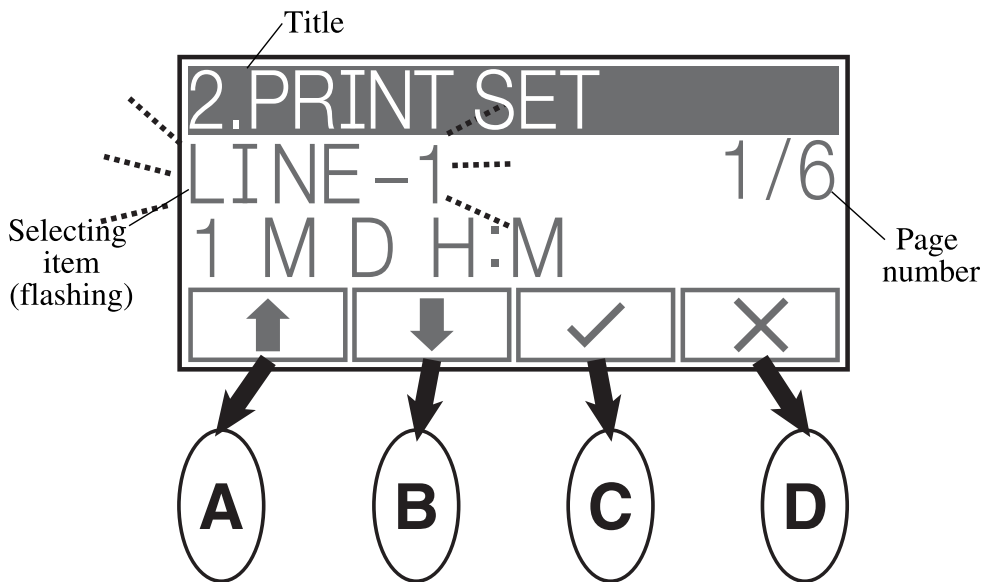

Functions of operation keys (A - D) are displayed by the icons on LCD. You can operate flashing item by clicking down the corresponding keys.

Icons

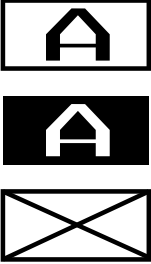
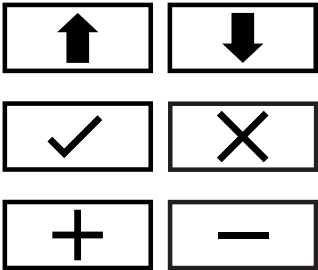
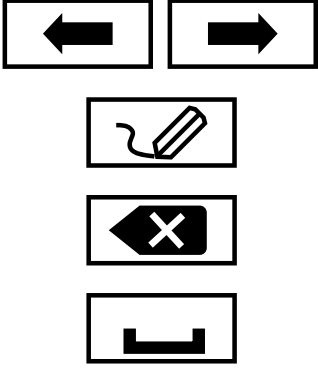
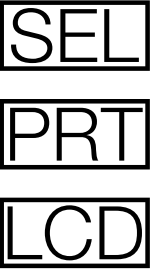
Icon	Function
	<p>Selectable print set (A, B, C, and D)</p> <p>Selected print set (A, B, C, or D)</p> <p>Unselectable print set</p> <p>[Note] The icon A, B, C, or D will not appear on the display when the corresponding print set is not installed.</p>
	<p>Previous / Next menu</p> <p>Set / Cancel</p> <p>Change value Select next / previous option</p>
	<p>Move the cursor to Left / Right</p> <p>Input mode</p> <p>Delete mode</p> <p>Insert mode</p>
	<p>Change Lock/Unlock of print set selection</p> <p>Change Lock/Unlock of punching Change ON/OFF of the light at print area</p> <p>Change ON/OFF of the light on the display</p>

Menu tree

[Note] The options with underline are default settings.

MENU	Selectable options		Explanation
1. CLOCK	TIME	HH:MM	<p>Set the current date and time for callendar and clock.</p> <p>[Note]</p> <ul style="list-style-type: none"> When you set D.S.T. period, the display shows "DST" during the D.S.T. period. When you select "7. NUMERIC" on "8. LANGUAGE", month (MMM) will be expressed by number. "TIME" and "DATE" of "1. CLOCK" can not be set by the setting file via USB stick.
	DATE	00 - 99 01 - 12 01 - 31 <u>1.</u> AM/PM, <u>2.</u> 24 HOURS <u>1.</u> DD MMM DOW, <u>2.</u> MMM DD DOW <u>3.</u> DOW DD MMM, <u>4.</u> DOW MMM DD	
2. PRINT SET	LINE-1	<u>1</u> - 31 [Refer to p.25 Format list]	<p>Set formats of each line, print position, time shift, and numbering counter.</p> <p>[Note]</p> <ul style="list-style-type: none"> When the setting is installed via USB stick, LT5000 can have up to 4 print sets. You can select a format from 1 to 31 on the device. When the setting is installed via USB stick, the display may show other format numbers from 32 to 37. When you select "1. SHIFT-1" on "5. TIME SHIFT", the shifted date and time is printed instead of the current date and time. When the setting is installed via USB stick, the display may show other shift No., SHIFT-2, 3, or 4. You can select only "COUNTER-1" on the device. When the setting is installed via USB stick, the display may show other counter No., COUNTER-2, 3, or 4.
	LINE-2	<u>0</u> - 31 [Refer to p.25 Format list]	
ALIGNMENT	SIDE	<u>1.</u> LEFT, <u>2.</u> RIGHT	<p>Set print style and comment.</p> <p>C1 (or 2)-FONT is to select print font of CUSTOM-1 (or 2).</p> <p>[Note]</p> <ul style="list-style-type: none"> When you select "1. AM/PM" on "HOURS", AM/PM is also printed before the time. CUSTOM-1 and 2 can be selected for print on setting of "LINE-1" or "LINE-2" on "2. FORMAT" as No. 30 and 31. To set CUSTOM-3, 4, 5, 6, 7, and 8, you need the setting file installing via USB stick. Leading zero is attached to month (in case "7. Numeric" is selected on "8. LANGUAGE"), date, and time. The setting will not affect year and numbering counter.
	TIME SHIFT	<u>1.</u> LEFT, <u>2.</u> CENTER, <u>3.</u> RIGHT	
COUNTER		<u>0.</u> N/A, <u>1.</u> SHIFT-1 <u>1.</u> COUNTER-1	
3. CONTENTS	YEAR	<u>1.</u> 2 DIGITS, <u>2.</u> 4 DIGITS	<p>Set rule of the numbering counter.</p> <p>[Note]</p> <ul style="list-style-type: none"> LT5000 records only punches with the counted number in the memory of the device. Once you change any parameter on this setting, value of the counter will go back to the initial number. Plus (+) means increment (count-up), and minus (-) means decrement (count-down). Number means repeat times. (0 means fixed counter.) When you select +3, the device prints same number three times, and steps up to the next number after that. When you select "1. STOP" on "LOOP", the counter stops at the maximum/minimum number, and you can not punch anymore. When you select "2. LOOP", the counter will start counting up (down) from the minimum (maximum) number again.
	HOURS	<u>1.</u> AM/PM, <u>2.</u> 24 HOURS	
MINUTE	<u>1.</u> 1/60, <u>2.</u> 1/100, <u>3.</u> 1/20, <u>4.</u> 1/10		
LEADING ZERO	<u>1.</u> WITHOUT <u>2.</u> WITH		
FIXED CMNT	<u>1</u> - 15 [Refer to p.25 Fixed comment list]		
C1-FONT	<u>1.</u> BOLD, <u>2.</u> LARGE, <u>3.</u> SMALL		
CUSTOM-1	(characters for the first line)		
C2-FONT	<u>1.</u> BOLD, <u>2.</u> LARGE, <u>3.</u> SMALL		
CUSTOM-2	(characters for the second line)		
4. COUNTER	DIGIT	<u>1</u> - 8	
	MAXIMUM	<u>1</u> - 999999999	
MINIMUM	<u>0</u> - 999999998		
INITIAL	<u>0</u> , <u>1</u> - 999999999		
REPEAT	-9, ..., -1, 0, +1, ..., +9		
LOOP	<u>1.</u> STOP, <u>2.</u> LOOP		
RESET	<u>1.</u> PROHIBIT, <u>2.</u> DAILY, <u>3.</u> MANUAL		
5. TIME SHIFT	DAY	00 - 14	<p>Set shifting days and time (to the future) to print instead of the current time.</p>
	TIME	HH:MM	
6. PROGRAM	DOW	SUN, MON, TUE, WED, THU, FRI, SAT	<p>Set programs to control print allowance and print set selection.</p> <p>You can specify the execution of the program by setting D.O.W. time, and action. There are three types of action as shown below. When the specified D.O.W. and time comes, the action (as programmed) will be executed. The program and action remains in effect until another program is executed which contains a different action of the same type.</p> <p>When you set to "--" on "DOW" of the weekly program, the program will be deleted.</p> <p>Types of action: P-LOC / P-UNL: Set to print lock / unlock. During the effective time of "P-LOC", punch is prohibited, and the light at print area is off. S-LOC / S-UNL: Set to print set selection lock / unlock. During the effective time of "S-LOC", selecting a print set is prohibited. SEL-A, B, C, or D: Change a print set to the specified print set at the execution time on the D.O.W. (You can also change print set by key operation even during the effective time of the program. However, when 10 seconds pass, it will automatically go back to the print set specified by the program. If you want to fix print set, you also need to make another program with S-LOC.)</p>
	TIME	HH:MM	
ACTION		P-LOC, P-UNL S-LOC, S-UNL SEL-A, SEL-B, SEL-C, SEL-D	

MENU	Selectable options	Explanation
7. PR.METHOD ACTIVATION	1. <u>AUTO</u> , 2. SEMI-AUTO, 3. MANUAL	Select a method of print activation. AUTO: When the paper sensor on the device detects a paper, the device starts to print the selected print set. SEMI-AUTO: You can punch by clicking down a key corresponding to the print set which you want to print, while the paper sensor on the device detects a paper. MANUAL: You can punch anytime by clicking down a key corresponding to the print set which you want to print. While 'MANUAL' is selected, the paper sensor is temporarily off.
8. LANGUAGE LANGUAGE	1. ENGLISH, 2. SPANISH, 3. GERMAN 4. FRENCH, 5. ITALIAN 6. PORTUGUESE, 7. NUMERIC	Select a language. [Note] • Selectable options are displayed in each language on the display.
9. D.S.T. START END CLEAR	YEAR MONTH DATE YEAR MONTH DATE 00 - 99 01 - 12 01 - 31 00 - 99 01 - 12 01 - 31	Set daylight saving time period. Once the start/end dates are set, the dates are calculated automatically every year. When the set date is in the last week of a month, the set date is regarded as the day of the week in the last week, even when the number of weeks in the month changes year after year. At 2:00AM on the first day of D.S.T. period, the device automatically gains one hour to show 3:00AM. When 3:00AM comes on the last day of D.S.T. period, the device automatically loses one hour and returns to 2:00AM. Printing hour and minute follows hour and minute shown on the device.
10. PASSWORD NUMBER	(4 digits) 0000 - 9999	Set a password to protect the settings and data. When you set to '0000', the password will be deleted.
11. DATA LOAD <USB> OUTPUT <USB> DELETE DEVICE NO. DATA FULL	SETTING DATA PUNCH DATA PUNCH DATA 001 - 999 1. PUNCH ONLY, 2. STOP	Functions about data and USB. LOAD <USB>: Install the setting data from USB stick. If succeed, "END" appears on the display. OUTPUT<USB>: Pick up the punch data to USB stick. If succeed, "END" appears on the display. DELETE: Delete the punch data from the device. DEVICE NO.: Set a device number of the device. DATA FULL: Set an action when the memory of the device is full.
LOCK PRINT SELECT	LOCK, UNLOCK LOCK, UNLOCK	[Note] • When '1. PUNCH ONLY' on "DATA FULL" is selected, you can continue to punch even while the memory of the device is full. However, punch data is not recorded in the memory. Once punch data is deleted from the memory by key operation on the device, the device can record punch data again. • Device No. is useful for the following cases: 1) managing punch data with more than one device. 2) specifying the setting file to be applied. Set LOCK/UNLOCK of print and print set selection. Every time you click down the corresponding key, LOCK/UNLOCK is selected in turn. This setting priors to weekly program. However, in case that 'UNLOCK' by this setting is selected while 'P-LOC' by weekly program is effective, the device will go back to 'LOCK' once the device is left for 10 minutes without any operation.
LIGHT PRINT LCD	ON, OFF ON, OFF	Set ON/OFF of light on LCD and at print area. Every time you click down the corresponding key, ON/OFF is selected in turn.
COUNTER RESET COUNTER-1 COUNTER-2 COUNTER-3 COUNTER-4 COUNTER-ALL	(current value) (current value) (current value) (current value) *****	Reset value of the counter and go back to the initial number. This operation is not available to COUNTER-1 when '1. PROHIBIT' on "RESET" of "4. COUNTER" is selected. The counter (which '1. PROHIBIT' is selected) is excluded even if reset by COUNTER-ALL is executed.

Format list

Y=Year, M=Month, D=Date, DOW=Day of the week, H=Hour, Min=Minute, S=Second
C=Comment, N=Number of the counter

No.	Format	Print Example	No.	Format	Print Example
1	M.D.H.Min	JAN 31 10:00	17	Y.M.D.C	'16 JAN 31 SENT
2	D.M.H.Min	31 JAN 10:00	18	C.D.H.Min	SENT 31 10:00
3	M.D.Y.H.Min	JAN 31 '16 10:00	19	N.M.D.Y	000123 JAN 31 '16
4	D.M.Y.H.Min	31 JAN '16 10:00	20	N.D.M.Y	000123 31 JAN '16
5	Y.M.D.H.Min	'16 JAN 31 10:00	21	N.Y.M.D	000123 '16 JAN 31
6	Y.M.D.H.Min.S	'16 JAN 31 10:00:00	22	M.D.Y.N	JAN 31 '16 000123
7	D.H.Min	31 10:00	23	D.M.Y.N	31 JAN '16 000123
8	DOW.D.H.Min	SU, 31 10:00	24	Y.M.D.N	'16 JAN 31 000123
9	Y.M.D	'16 JAN 31	25	N.D.H.Min	000123 31 10:00
10	M.D	JAN 31	26	N.M.D.H.Min	123 JAN 31 10:00
11	DOW.D.M.Y	SU, 31 JAN '16	27	N.Y.M.D.H.Min	123 '16 JAN 31 10:00
12	C.M.D.Y	SENT JAN 31 '16	28	N.Y.M.D.H.Min.S	123 '16 JAN 31 10:00:00
13	C.D.M.Y	SENT 31 JAN '16	29	N	000123
14	C.Y.M.D	SENT '16 JAN 31	30	CUSTOM-1	
15	M.D.Y.C	JAN 31 '16 SENT	31	CUSTOM-2	
16	D.M.Y.C	31 JAN '16 SENT			

[Note] No. 32-37 of format numbers are allocated for the customized comments (CUSTOM 3-8). They are additional function by the setting file via USB stick.

Fixed comment list

No.	Comment	No.	Comment	No.	Comment
1	RCVD (Received)	6	FILED	11	ORIGIN (Original)
2	SENT	7	PAID	12	APR'D (Approved)
3	IN	8	USED	13	CMPL'D (Completed)
4	OUT	9	FAXED	14	START
5	CFMD (Confirmed)	10	VOID	15	END

Character list

Character		0	1	2	3	4	5	6	7	8	9
Dots	Bold	7	7	7	7	7	7	7	7	7	7
	Large	6	6	6	6	6	6	6	6	6	6
	Small	5	5	5	5	5	5	5	5	5	5

Character		A	B	C	D	E	F	G	H	I	J
Dots	Bold	7	7	7	7	7	7	7	7	4	7
	Large	6	6	6	6	6	6	6	6	3	6
	Small	5	5	5	5	5	5	5	5	3	5

Character		K	L	M	N	O	P	Q	R	S	T
Dots	Bold	7	7	7	7	7	7	7	7	7	6
	Large	6	6	7	6	6	6	6	6	6	5
	Small	5	5	5	5	5	5	5	5	5	5

Character		U	V	W	X	Y	Z				
Dots	Bold	7	7	7	7	6	7				
	Large	6	6	7	6	5	6				
	Small	5	5	5	5	5	5				

Character		'	*	+	,	-	.	/	:	;	_
Dots	Bold	2	6	6	4	6	4	7	4	4	5
	Large	2	5	5	3	5	3	5	3	3	4
	Small	2	5	5	3	4	3	5	3	3	3

Character		&	#	\$	@	[\]	^	`	{
Dots	Bold	9	8	8	8	6	7	6	7	4	6
	Large	8	6	5	6	5	5	5	5	3	5
	Small	7	5	5	5	4	5	4	3	2	4

Character			}	~	(EUR)	Pt	(Space)				
Dots	Bold	4	6	6	7	10	3				
	Large	3	5	5	6	7	2				
	Small	3	4	5	5	7	1				

Character		a	b	c	d	e	f	g	h	i	j
Dots	Small	4	4	4	4	4	3	4	4	1	2

Character		k	l	m	n	o	p	q	r	s	t
Dots	Small	4	1	5	4	4	4	4	4	4	3

Character		u	v	w	x	y	z				
Dots	Small	4	4	5	5	4	5				

Language - Specific Character

Character		ı	Ñ	ı	´	¨	ñ	§	Ä	Ö	Ü
Dots	Bold	4	7	6	4	8	6	7	7	7	7
	Large	3	6	5	3	6	6	6	6	6	6
	Small	3	5	5	2	6	5	5	5	5	5

Character		ä	ö	ü	ß	à	°	ç	é	ù	è
Dots	Bold	6	6	6	7	6	3	6	6	6	6
	Large	6	5	5	6	6	3	5	5	5	5
	Small	4	4	4	5	4	3	4	4	4	4

Character		É	ò	ì	Am	Pm	(Clock)				
Dots	Bold	7	6	4	11	11	7				
	Large	6	5	3	11	11	7				
	Small	5	4	3	10	10	7				

[Note]

Printable characters depend on the selected language.

Control code list

By inserting these control characters in customized comments, the following are available.

- 1) Date, time, value of the counter, and the device No. can be printed.
- 2) Current time / shifted time can be switched.
- 3) Printing font can be changed.

[Note]

- To print shifted time, you have to set on "5. TIME SHIFT".
- Control characters for fonts are not selectable on the device. (Just displayed.) On the device, you can select font on "C1 (or 2)-FONT" of "3. CONTENTS". As far as you set contents of the customized comment on the device, you can use only one type of font for one customized comment.
- It is not possible to include several counters in one customized comment.
- It is not possible to include several time shifts in one customized comment.

Code	Action	Explanation
Ÿ	Year	Expand year into customized comment. Actual number of dots depends on the setting.
Ṁ	Month	Expand month into customized comment. Actual number of dots depends on the setting. To print month by number, set '7. NUMERIC' on "8. LANGUAGE".
Ḍ	Day	Expand day into customized comment. Actual number of dots depends on the setting.
Ẃ	D.O.W.	Expand D.O.W. into customized comment. Actual number of dots depends on the setting.
Ḥ	HH:MM	Expand time (HH:MM) into customized comment. Actual number of dots depends on the setting.
ḥ	HH:MM:SS	Expand time (HH:MM:SS) into customized comment. Actual number of dots depends on the setting.
Ḑ	Counter	Expand counter into customized comment. Actual number of dots depends on the setting.
Ṫ	Time shift	Turn on/off time shift. (Default is off.) [Note] Once time shift is turned on by this code, it is effective until the same code is input again.
Ṇ	Device No.	Expand its device number into customized comment.
Ḃ	Bold font	(Additional function via USB) Change characters to Bold font. [Note] You can not set this code on the device.
Ḍ	Large font	(Additional function via USB) Change characters to Large font. [Note] You can not set this code on the device.
Ṡ	Small font	(Additional function via USB) Change characters to Small font. [Note] You can not set this code on the device.

Printing position

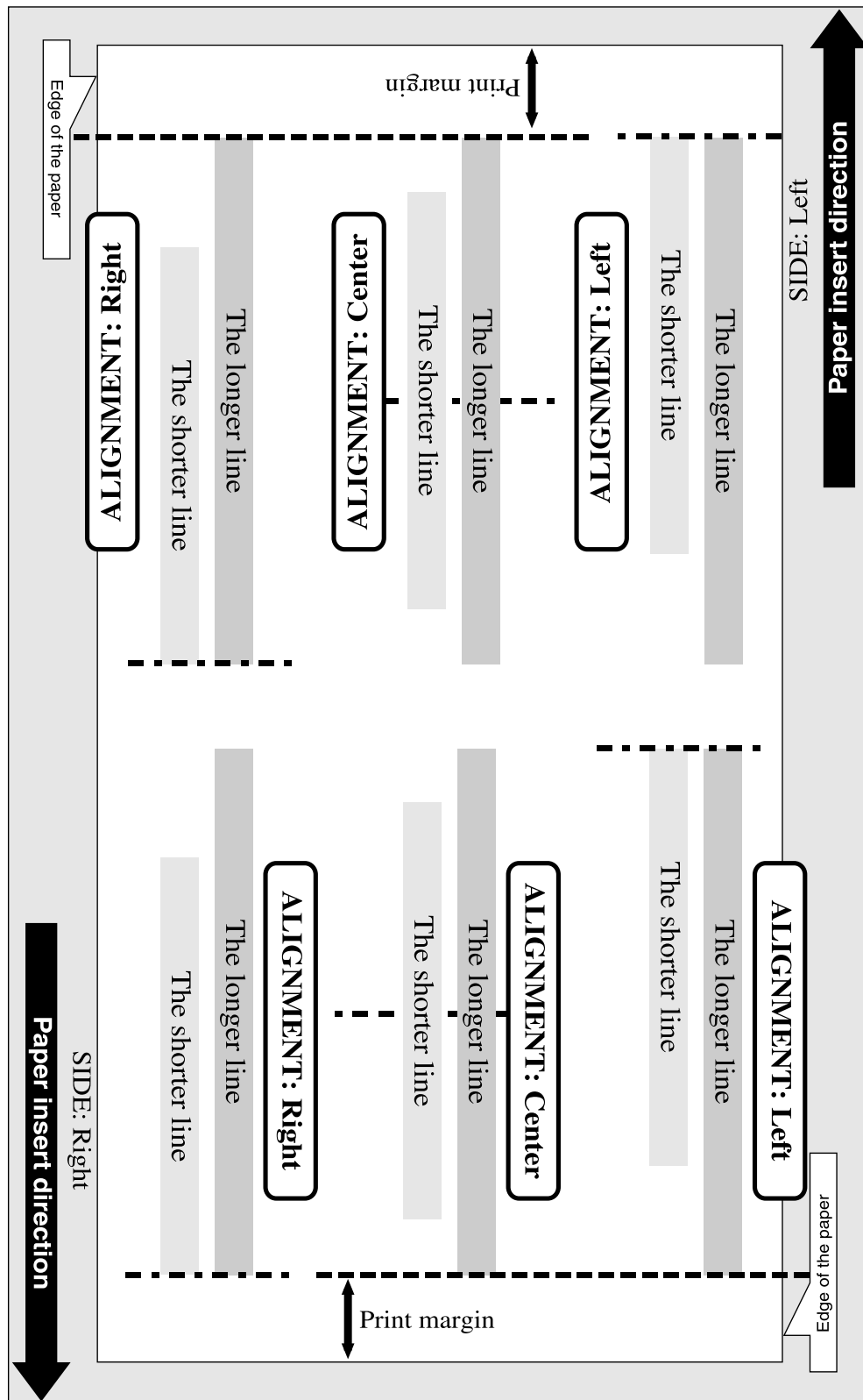

You can change "Print margin" by sliding the lever on the bottom of the device.

Error / Warning code list

Warning

No.	Display	Causes	Action
W05	INSERT AGAIN !	The paper is not inserted properly.	Insert the paper again during W05 is displayed (10 sec.). During the 10 sec. time for printing is kept at the time when W05 was indicated.
W07	NO PRINT DATA	1) No print set is found. 2) CUSTOM-1 (or 2) has no contents.	Set a format on "LINE-1" of "2. PRINT SET". Set "CUSTOM-1 (or 2)" of "3. CONTENTS".
W08	COUNTER LIMIT	The value of the counter reaches limit (maximum or minimum number).	Set '2. LOOP' on "LOOP" of "4. COUNTER", or reset the counter.
W09	MEMORY FULL	Memory in the device is full.	Set '1. PUNCH ONLY' on "DATA FULL" of "11. DATA", or delete punch data.
W40	PASSWORD ERROR	Password is incorrect.	Input the correct password.
W41	DST SETTING ERR	Start/end date of DST is incorrect.	Set the correct start/end date of D.S.T.
W49	SETTING ERROR	1) Total length of the customized comment is over 47 characters or 160 dots. 2) Setting of "4. COUNTER" is incorrect.	Make a customized comment less than 160 dots in total, referring to the character list. Set the correct value for maximum and minimum numbers.
W61	NO PUNCH DATA	No data to be picked up is in the memory of the device.	Check the format whether it includes a counter first. After that, punch and try it again.
W62	WRITING ERROR	Data can not be written in the USB stick.	Use another USB stick.
W63	READING ERROR	Data can not be read out from the USB stick.	
W64	FILE NOT FOUND	No setting file is found.	Store the correct setting file in the USB stick, and try it again.
W65	USB STICK FULL	The USB stick does not have enough space.	Delete data in the USB stick, or use another USB stick which has enough space.
W66	CHECK ERR FILE !	Setting file has error.	Check error file in the USB stick.
W67	USB PROTECTED	The USB stick is protected physically or by software.	Check the protection status of the USB stick, and try it again.
W68	USB STICK ERROR	The USB stick can not be used on the device.	Use another USB stick.

Error

No.	Display	Causes	Action
E00	PROGRAM ERROR	CPU error	Try reset first. If this error is still displayed after reset, contact the shop from whom you bought your device.
E01	BACK UP ERROR	The remaining life of battery for memory back-up is short.	
E15	SENSOR ERROR	Sensor error	
E16 E17	PROGRAM ERROR	Memory error	
E30 E32 E38 E39	H. POSITION ERROR MECHANICAL ERR	Printing can not be performed. A printer motor or sensor is not normal.	Make sure that debris are not inside print area, and the ribbon cassette is correctly installed in place. After that, try reset. If this error is still displayed after reset, contact the shop from whom you bought your device.
E60 E69	USB ERROR USB POWER FAIL.	USB error	Try reset, or use another USB stick. If this error is still displayed after reset, contact the shop from whom you bought your device.

Recovery from error / warning

Warning (Wxx): Automatically recover from the warning.

Error (Exx): Push the setting button for 3 seconds.

Reset

Initialization

Click down the reset button after removing the cover.

[Note] Any setting shall be kept.

All clear

Click down the reset button while pressing the key A and C after removing the cover.

[Note]

- All settings including date and time will be deleted, and the device will go back to the default settings.
- Punch data stored in the device is not deleted.

Troubleshooting

If your device does not work normally and no Error/Warning code is shown on the display, check the items listed below.

Before checking them, make sure to initialize the device first. (Refer to p.30 Reset.)

The device does not work. (Nothing is shown on the display).

- Check the power cord is properly plugged into the AC outlet.

The paper is jammed.

- Push the setting button for 3 seconds, and pull out the paper during initialization.

Can not punch.

- Check the ink ribbon cassette is installed correctly. (Refer to p.8 Replacing ink ribbon cassette.)
- Check the device is on the standby mode which shows clock on the display.
- Check the setting on "ACTIVATION" of "7.PR.METHOD". In case that '3. MANUAL' is selected, you have to click down the key corresponding to the print set to start punching.
- Check the settings on "4. COUNTER". The counter included in the print set may have reached the maximum (or minimum) number.
- Check the setting on "DATA FULL" of "11. DATA". The memory of the device may be full.
- Check the setting on "PRINT" of "LOCK".
- Check the programs on "6. PROGRAM". P-LOC may be effective. Make another program with P-UNL in this case.

Printing direction is upside down. Printing position is different from what you want.

- Check the settings on "SIDE" and "ALIGNMENT" of "2. PRINT SET". (Refer to p.9 Printing position.)

How to adjust print position.

- The paper guide gauge and the slide lever are available on the device. They will help you to position the paper.

How to print month by number.

- Set "8. LANGUAGE" to '7. NUMERIC'.

Can not select a print set.

- Check the setting on "PRINT" of "LOCK".
- Check the programs on "6. PROGRAM". S-LOC may be effective. Make another program with S-UNL in this case.
- The device has only one print set.

Light at print area is off.

- Check the setting on "PRINT" of "LIGHT".
 - Check the programs on "6. PROGRAM". P-LOC may be effective. Make another program with P-UNL in this case.
-

Print set is automatically changed.

- Check the programs on "6. PROGRAM". SEL-A (B, C, or D) may be effective.
-

Date and time is not printed correctly.

- Check the setting on "TIME SHIFT" of "2. PRINT SET". Time shift (SHIFT-1 (2, 3, or 4)) may be effective on the print set.
-

Punch data is not recorded.

- Check whether the selected format includes the counter. Punch data without value of the counter is not stored in the memory of the device.
-

How can I delete password from the device ?

- Once you set to '0000' as the password on "10. PASSWORD", the password setting can be deleted.
-

How can I print the format, "CUSTOM-1 (or 2)" I made ?

- Check the format number on "LINE-1 (or 2)" of "2. PRINT SET". (Refer to p.25 Format list.)
-

What means "---/160" on "CUSTOM-1 (or 2)" ?

- It shows total dots of the customized comment. 160 means maximum dots of one customized comment. In case that 'CUSTOM-1 (or 2)' is not selected on "LINE-1 (or 2)" of "2. PRINT SET", ---/160 is shown on the display.

If the trouble is not solved even though you checked the listed items, please contact the shop from whom you bought the device.

Specifications

Clock accuracy	Monthly accuracy \pm 15 sec. (at ordinary temperature)
Calendar	Year up to 2099. Automatically adjusted to leap years, 31-day months and months with thirty or fewer days, and the days of the week.
Printing system	Dot matrix imprint
Power failure compensation	Three years of cumulative power failure hours after the date of shipment
Print at power failure	Optional battery, 100 times printing or 24 hours (option)
Operating environment	Temperature: -5°C to $+45^{\circ}\text{C}$: $+23^{\circ}\text{F}$ to $+113^{\circ}\text{F}$ Humidity: 20% to 80%RH, no condensation The device operates normally at temperatures of 5°C or below, but the print density, reaction of the liquid crystal display, and the number of prints at power failure are inferior to those at normal temperature operation.
Dimensions	156(W) x 179(D) x 181(H) mm 6-5/32"(W) x 7-1/16"(D) x 7-1/8"(H)
Weight	Approx. 1.9kg (4.2lbs)
Power consumption	120VAC 50/60Hz 0.6A 220-240VAC 50/60Hz 0.4A
Memory	1,022 punch data or less

- Optional battery (not included) for 100% printer operation during power failures is available. Order part no. VIS6001
- Ni-MH Battery rated 8.4V, 500mAh. Caution: Replace only with the same type of battery specified by the manufacturer.
- Place the time recorder at the position close to the wall outlet so that it is easily accessible to disconnect.
- Lithium battery contains perchlorate material - special handling may apply.
Please go to the web site <http://www.dtsc.ca.gov/hazardouswaste/perchlorate> for information about proper methods of disposal.

Environmental conditions

Avoid placing the device in environments that are:

- humid or dusty
- exposed to direct sunshine
- subject to frequent or continuous vibrations
- outside the temperature range between -5°C and 45°C ($+23^{\circ}\text{F}$ and $+113^{\circ}\text{F}$)
- affected by chemicals or ozone

Limited One-Year Warranty

Lathem warrants the hardware products described in this guide against defects in material and workmanship for a period of **one year** from date of original purchase from Lathem or from an authorized Lathem reseller. The conditions of this warranty and the extent of the responsibility of Lathem Time Corporation ("Lathem") under this warranty are listed below.

1. This warranty will become void when service performed by anyone other than an approved Lathem warranty service dealer results in damage to the product.
2. This warranty does not apply to any product which has been subject to abuse, neglect, or accident, or which has had the serial number altered or removed, or which has been connected, installed, adjusted, or repaired other than in accordance with instructions furnished by Lathem.
3. This warranty does not cover dealer labor cost for removing and reinstalling the machine for repair, or any expendable parts that are readily replaced due to normal use.
4. The sole responsibility of Lathem under this warranty shall be limited to repair of this product, or replacement thereof, at the sole discretion of Lathem.
5. If it becomes necessary to send the product or any defective part to Lathem or any authorized service dealer, the product must be shipped in its original carton or equivalent, fully insured with shipping charges prepaid. Lathem will not assume any responsibility for any loss or damage incurred in shipping.
6. **WARRANTY DISCLAIMER AND LIMITATION OF LIABILITY:** Except only the limited express warranty set forth above, the products are sold with no expressed or implied warranties of any kind, and the implied warranties of merchantability and fitness for a particular purpose are hereby expressly disclaimed. No warranties are given with respect to products purchased other than from Lathem or an authorized Lathem reseller and any such products are purchased "as is, with all faults." In no event will Lathem be liable for any direct, indirect, special, incidental or consequential damages arising out of or in connection with the delivery, use or inability to use, or performance of this product. In the event any limited remedy given herein shall be deemed to have failed of its essential purpose, Lathem's maximum liability shall be to refund the purchase price upon return of the product.
7. Proof of date of purchase from Lathem or an authorized Lathem reseller is required for warranty service on this product.
8. This Warranty grants specific legal rights. Additional legal rights, which may vary by locale, may also apply.
9. Should any difficulties arise with the performance of this product during warranty, or with any Lathem authorized service centers, contact Lathem Time at the address below.

Lathem Time | 200 Selig Drive, SW, Atlanta, GA 30336 | 404-691-0405

